

CAS325M12HM2

1.2kV, 3.6 mΩ All-Silicon Carbide High Performance, Half-Bridge Module C2M MOSFET and Z-Rec™ Diode

V_{DS}	1.2 kV
$E_{sw, Total @ 600V, 300A}$	9.3 mJ
$R_{DS(on)}$	3.6 mΩ

Features

- Ultra Low Loss, Low (5 nH) Inductance
- Ultra-Fast Switching Operation
- Zero Reverse Recovery Current from Diode
- Zero Turn-off Tail Current from MOSFET
- Normally-off, Fail-safe Device Operation
- AlSiC Baseplate and Si3N4 AMB Substrate
- Ease of Paralleling
- High Temperature Packaging, $T_{J(max)} = 175\text{ °C}$
- AS9100 / ISO9001 Certified Manufacturing

System Benefits

- Enables Compact, Lightweight Systems
- High Efficiency Operation
- Reduced Thermal Requirements

Applications

- High-Efficiency Converters / Inverters
- Motor & Traction Drives
- Smart-Grid / Grid-Tied Distributed Generation

Package 65mm x 110mm x 10mm

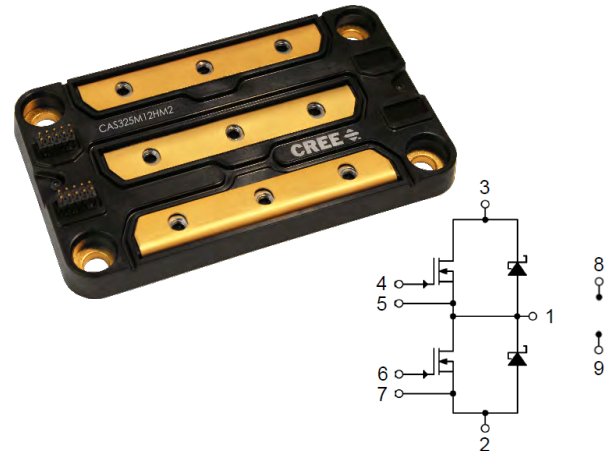

Part Number	Package	Marking
CAS325M12HM2	Half-Bridge Module	CAS325M12HM2

Maximum Ratings ($T_c = 25\text{ °C}$ unless otherwise specified)

Symbol	Parameter	Value	Unit	Test Conditions	Notes
V_{DSmax}	Drain - Source Voltage	1.2	kV		
V_{GSmax}	Gate - Source Voltage, Maximum values	-10/+25	V	$T_J = -55$ to 150 °C	
		-10/+23		$T_J = -55$ to 175 °C	
V_{GSop}	Gate - Source Voltage, Recommended Operation values	-5/+20	V	$T_J = -55$ to 150 °C	
		-5/+18		$T_J = -55$ to 175 °C	
I_D	Continuous Drain Current	444	A	$T_c = 25\text{ °C}, T_J = 175\text{ °C}$	Fig. 17
		256		$T_c = 125\text{ °C}, T_J = 175\text{ °C}$	
T_{Jmax}	Junction Temperature	175	°C		
T_c, T_{STG}	Case and Storage Temperature Range	-55 to +175	°C		
V_{isol}	Case Isolation Voltage	1.2	kV	AC, 50 Hz, 1 min	
P_D	Power Dissipation	1500	W	$T_c = 25\text{ °C}, T_J = 175\text{ °C}$ (per switch)	Fig. 16

Electrical Characteristics ($T_c = 25^\circ\text{C}$ unless otherwise specified)

Symbol	Parameter	Min.	Typ.	Max.	Unit	Test Conditions	Note
V_{DSS}	Drain - Source Blocking Voltage	1.2			kV	$V_{GS} = -5\text{ V}, I_D = 2\text{ mA}$	
$V_{GS(th)}$	Gate Threshold Voltage	2.0	2.6	4	V	$V_{DS} = V_{GS}, I_D = 105\text{ mA}$	
			2.0			$V_{DS} = V_{GS}, I_D = 105\text{ mA}, T_J = 175^\circ\text{C}$	
I_{DSS}	Zero Gate Voltage Drain Current		720	2000	μA	$V_{DS} = 1.2\text{ kV}, V_{GS} = -5\text{ V}$	
I_{GSS}	Gate-Source Leakage Current			3.5	nA	$V_{GS} = 20\text{ V}, V_{DS} = 0\text{ V}$	
$R_{DS(on)}$	On State Resistance		3.6	4.3	m Ω	$V_{GS} = 20\text{ V}, I_{DS} = 400\text{ A}$	Fig. 5
			7.6			$V_{GS} = 18\text{ V}, I_{DS} = 400\text{ A}, T_J = 175^\circ\text{C}$	
C_{iss}	Input Capacitance		19.5		nF	$V_{GS} = 0\text{ V}, V_{DS} = 1000\text{ V}, f = 1\text{ MHz}, V_{AC} = 25\text{ mV}$	Fig. 11, 12
C_{oss}	Output Capacitance		1.54				
C_{rss}	Reverse Transfer Capacitance		0.10				
E_{on}	Turn-On Switching Energy		5.6		mJ	$V_{DD} = 600\text{ V}, V_{GS} = -5\text{V}/+20\text{V}$ $I_D = 300\text{ A}, R_{G(ext)} = 2\Omega$ Note: IEC 60747-8-4 Definitions	Fig. 13
E_{off}	Turn-Off Switching Energy		3.7				
Q_{GS}	Gate-Source Charge		322		nC	$V_{DS} = 800\text{ V}, V_{GS} = -5\text{V}/+20\text{V},$ $I_D = 350\text{ A},$ Per IEC 60747-8-4	
Q_{GD}	Gate-Drain Charge		350				
Q_G	Total Gate Charge		1127				

Free-Wheeling SiC Schottky Diode Characteristics

Symbol	Parameter	Min.	Typ.	Max.	Unit	Test Conditions	Note
V_{SD}	Diode Forward Voltage		1.7	2.0	V	$I_F = 350\text{ A}, V_{GS} = -5\text{ V}$	Fig. 6
			2.5	2.8		$I_F = 350\text{ A}, T_J = 175^\circ\text{C}, V_{GS} = -5\text{ V}$	
Q_C	Total Capacitive Charge		4.3		μC	Includes Schottky & Body diodes	

Note: The reverse recovery is purely capacitive

Thermal Characteristics

Symbol	Parameter	Min.	Typ.	Max.	Unit	Test Conditions	Note
R_{thJCM}	Thermal Resistance Junction-to-Case for MOSFET	0.085	0.100	0.115	$^\circ\text{C}/\text{W}$		Fig. 18,19
R_{thJCD}	Thermal Resistance Junction-to-Case for Diode	0.094	0.110	0.127			

Additional Module Data

Symbol	Parameter	Min.	Typ.	Max.	Unit	Test Condition
W	Weight		140		g	
M	Mounting Torque	0.9	1.1	1.3	Nm	Power Terminals, M4 Bolts
		3	4.5	5		Baseplate, M6 Bolts
L_{CE}	Loop Inductance		5		nH	

Typical Performance

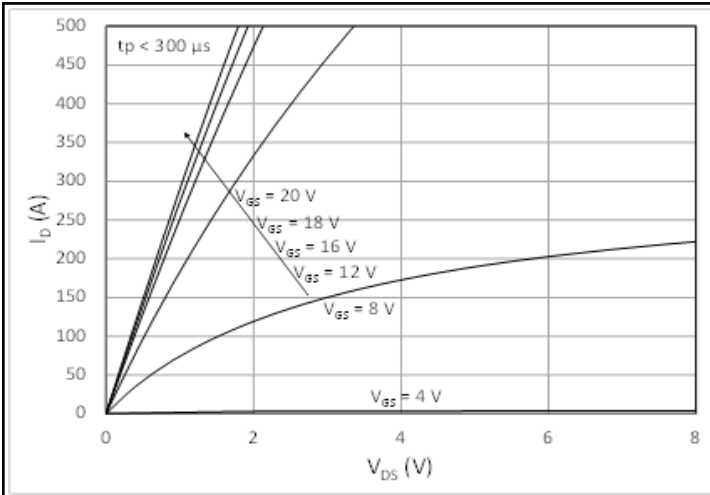

Figure 1. Typical Output Characteristics $T_J = 25\text{ }^\circ\text{C}$

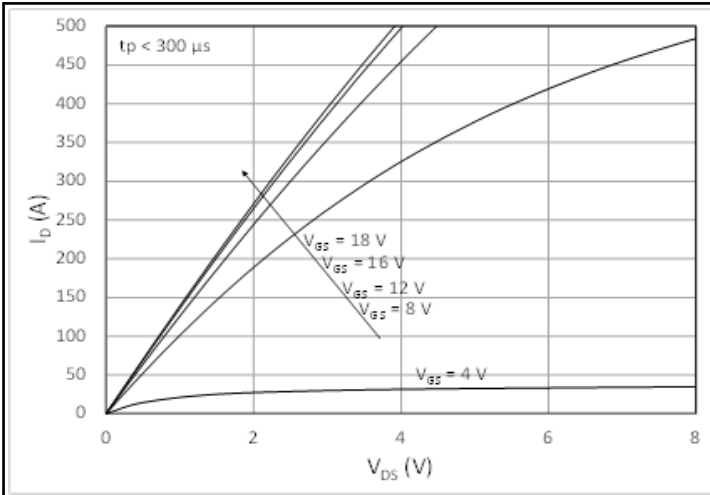

Figure 2. Typical Output Characteristics $T_J = 175\text{ }^\circ\text{C}$

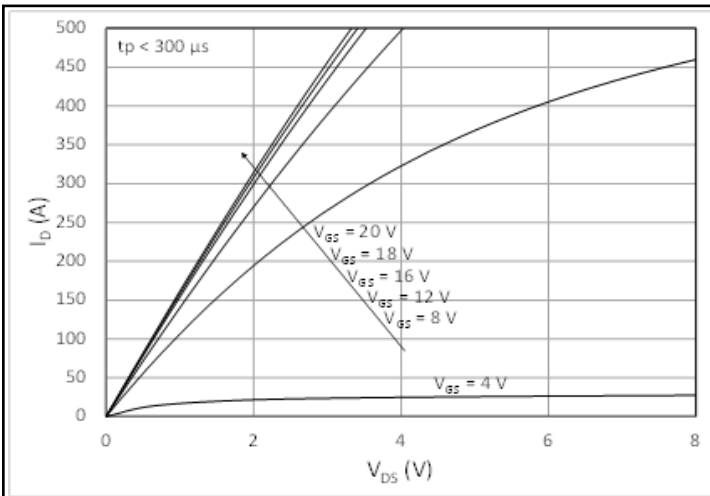

Figure 3. Typical Output Characteristics $T_J = 150\text{ }^\circ\text{C}$

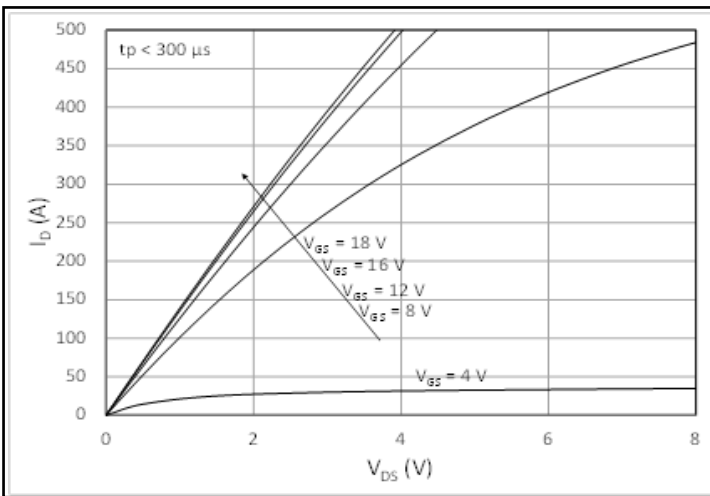

Figure 4. Typical Output Characteristics $T_J = 175\text{ }^\circ\text{C}$

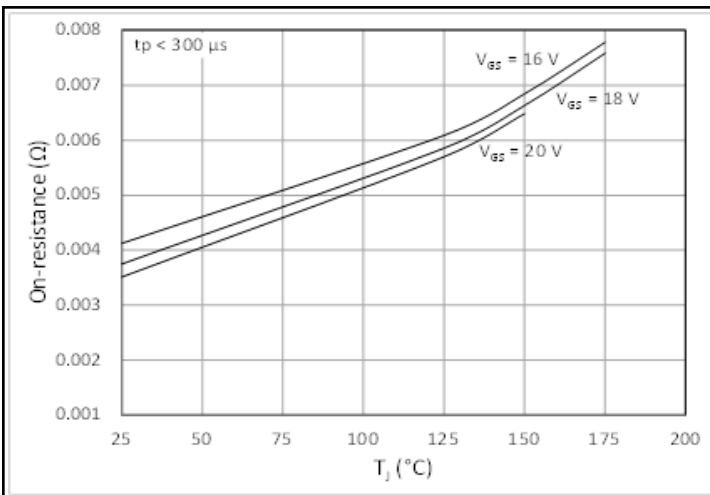

Figure 5. On-Resistance vs. Temperature for Various Gate-Source Voltage

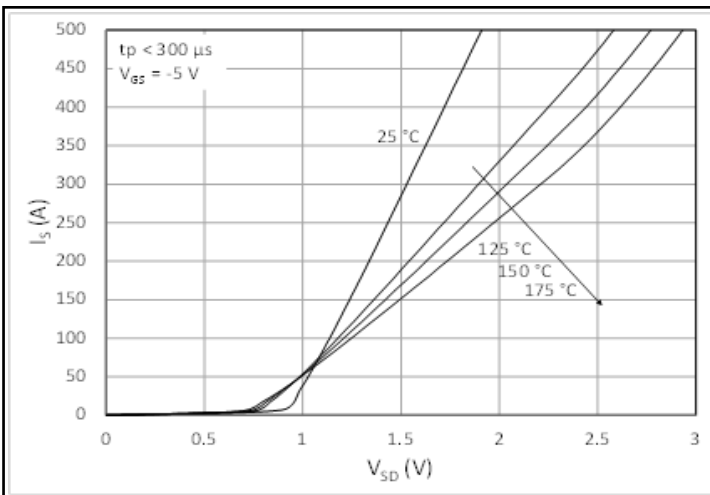

Figure 6. Antiparallel Diode Characteristic, $V_{GS} = -5\text{ V}$

Typical Performance

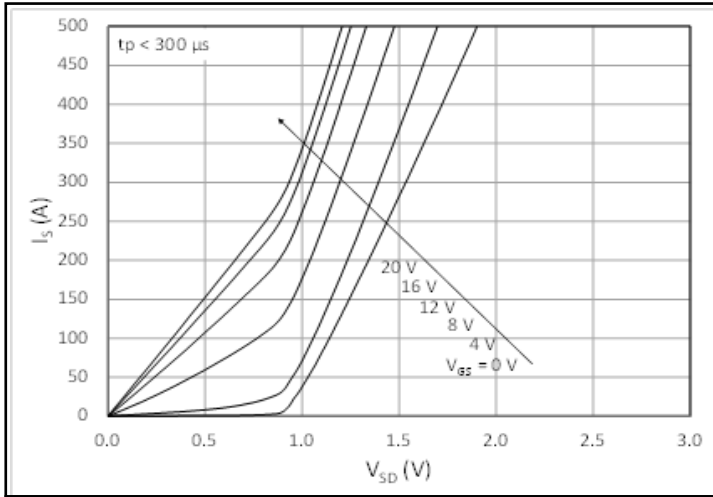

Figure 7. 3rd Quadrant Characteristic at 25 °C

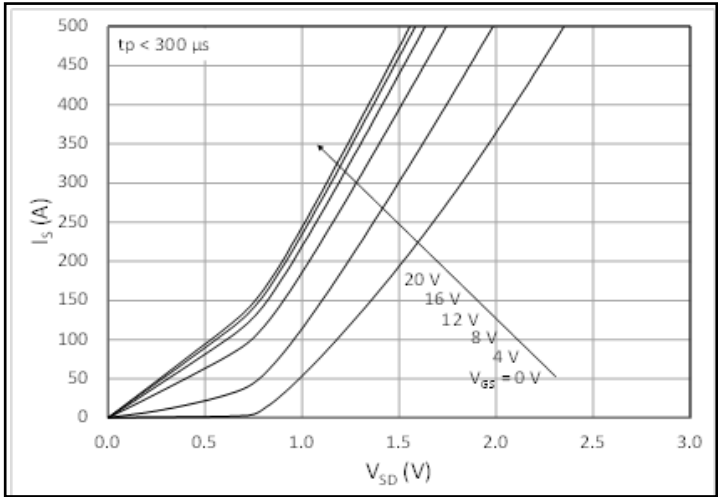

Figure 8. 3rd Quadrant Characteristic at 125 °C

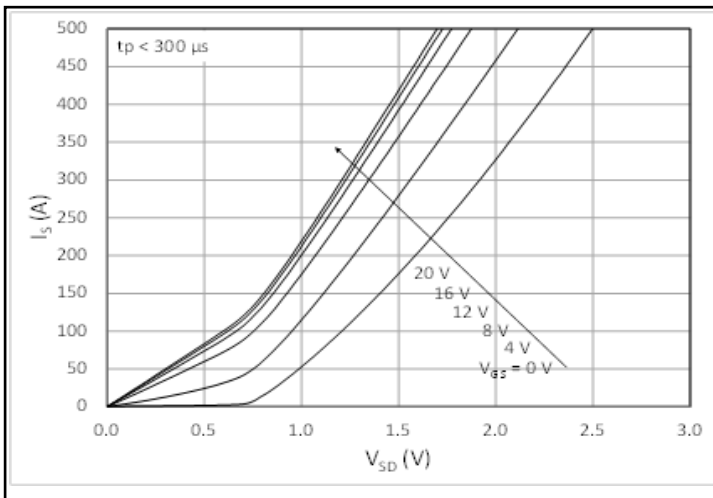

Figure 9. 3rd Quadrant Characteristic at 150 °C

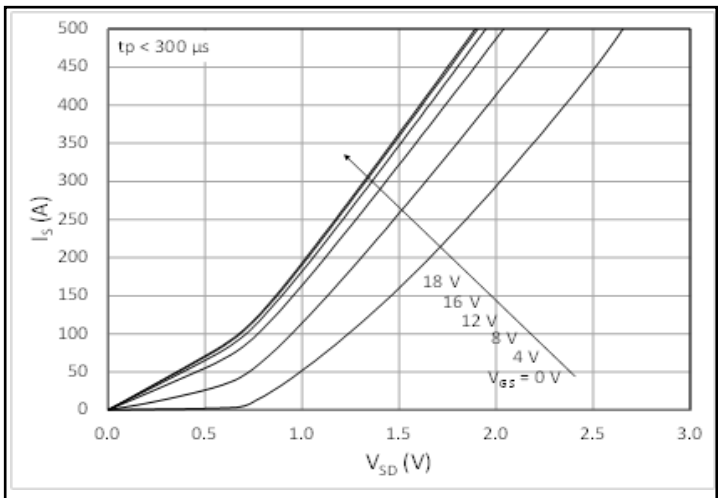

Figure 10. 3rd Quadrant Characteristic at 175 °C

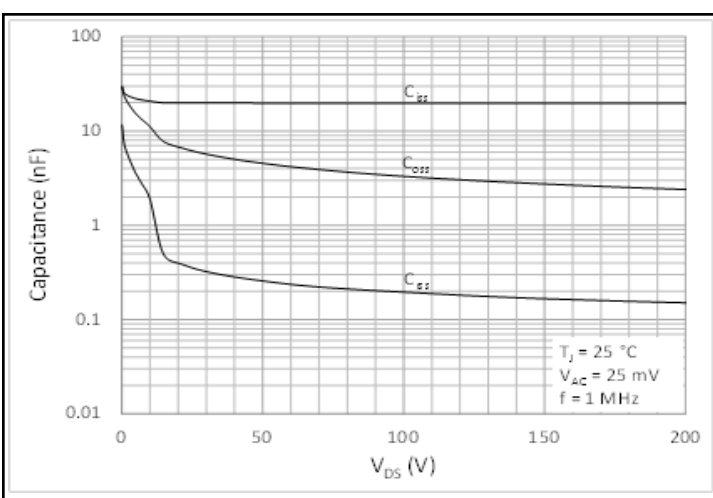

Figure 11. Typical Capacitances vs. Drain-Source Voltage (0 - 200 V)

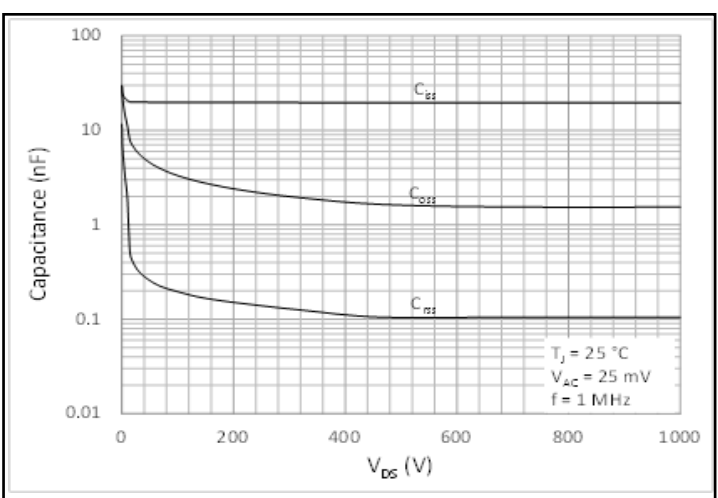

Figure 12. Typical Capacitances vs. Drain-Source Voltage (0 - 1 kV)

Typical Performance

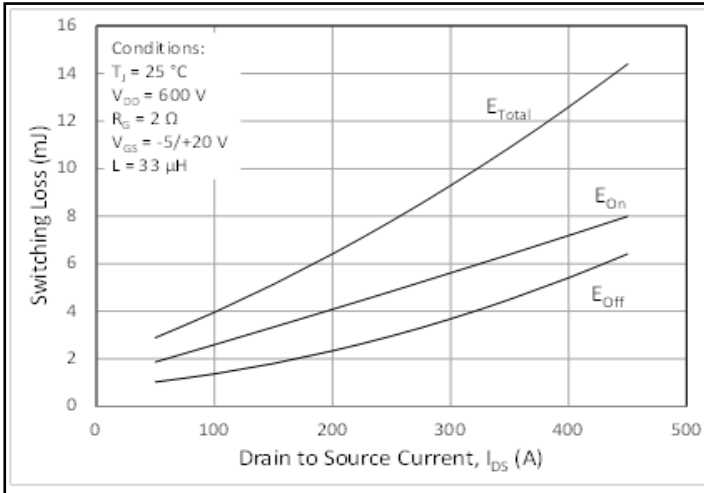

Figure 13. Inductive Switching Energy vs. Drain Current For $V_{DD} = 600\text{V}$, $R_G = 2\ \Omega$

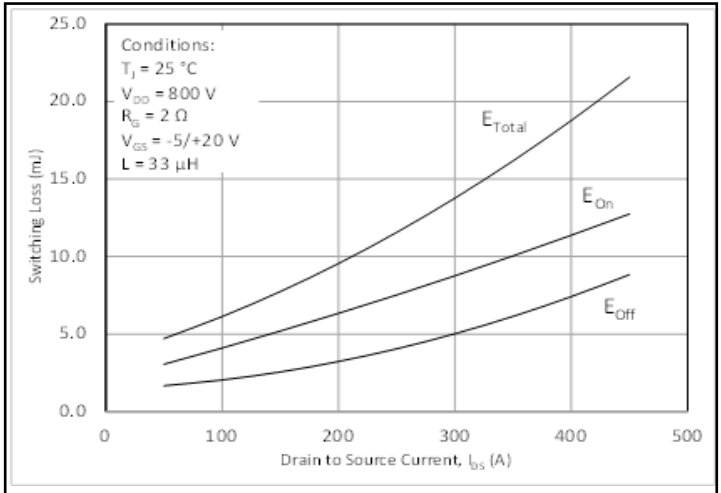

Figure 14. Inductive Switching Energy vs. Drain Current For $V_{DD} = 800\text{V}$, $R_G = 2\ \Omega$

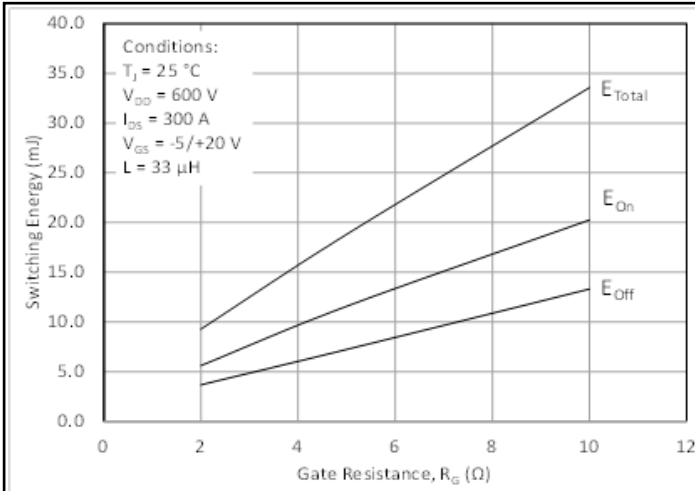

Figure 15. Inductive Switching Energy vs. Gate Resistance, $I_{DS} = 300\text{A}$

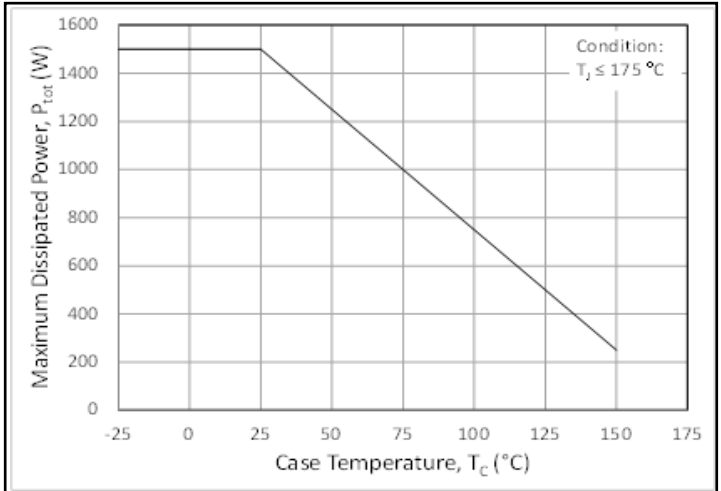

Figure 16. Maximum Power Dissipation (MOSFET) Derating Per Switch Position vs Case Temperature

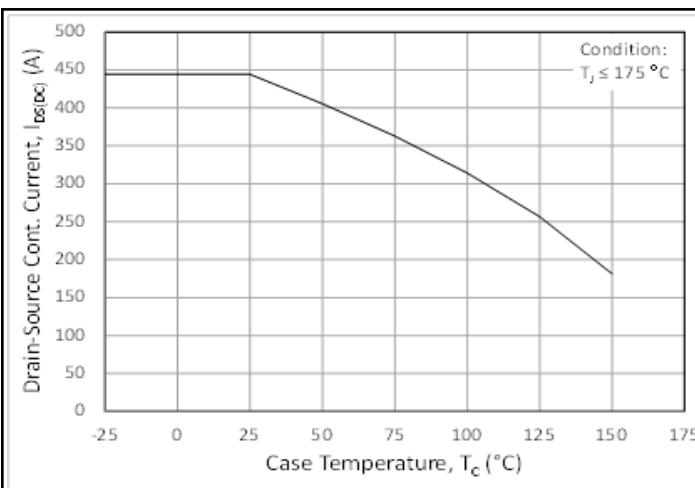

Figure 17. Continuous Drain Current Derating vs Case Temperature

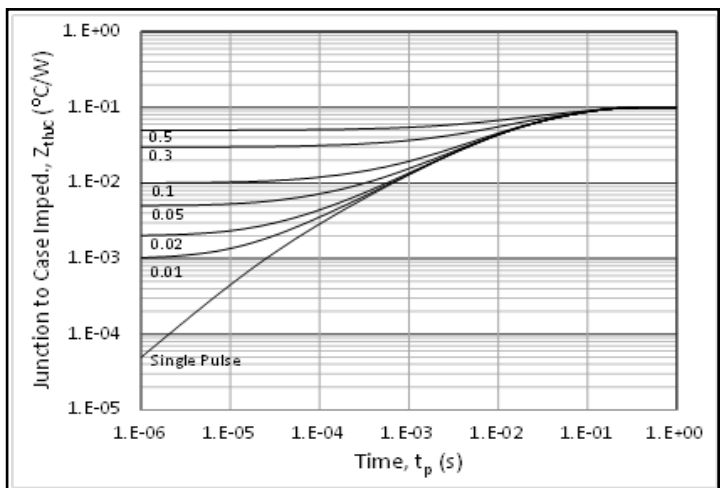

Figure 18. MOSFET Junction to Case Thermal Impedance

Typical Performance

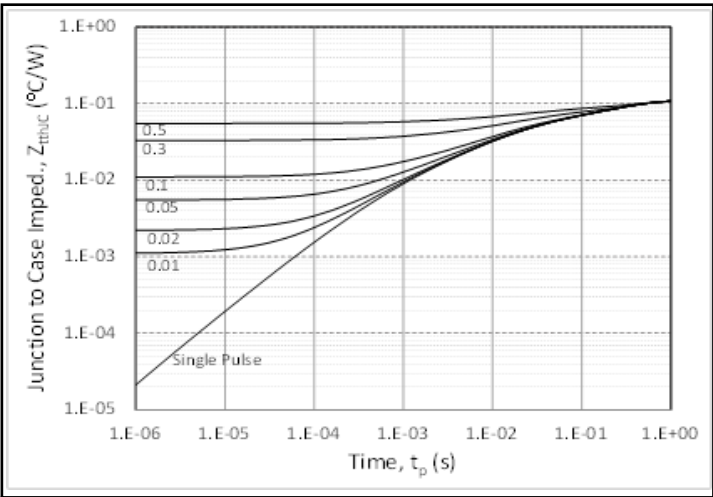
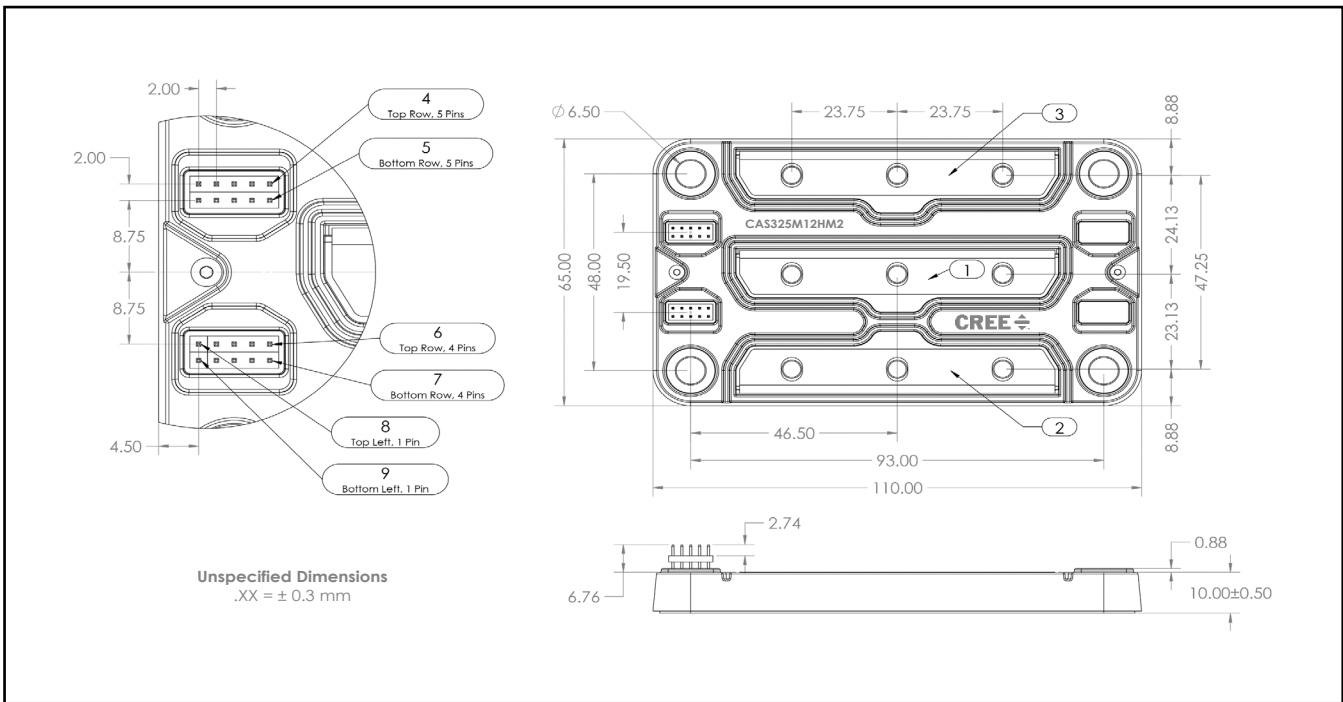

Figure 19. Diode Junction to Case Thermal Impedance

Package Dimensions (mm)





Important Notes

- The SiC MOSFET module switches at speeds beyond what is customarily associated with IGBT-based modules. Therefore, special precautions are required to realize the best performance. The interconnection between the gate driver and module housing needs to be as short as possible. This will afford the best switching time and avoid the potential for device oscillation. Also, great care is required to insure minimum inductance between the module and DC link capacitors to avoid excessive VDS overshoot.
- The module utilizes the ESQT-105-02-G-D-XXX family of elevated socket connectors from Samtec, available in varying height according to the customer's preference
- Companion Parts: CGD15HB62LP + High Performance Three Phase Evaluation Unit
- Some values were obtained from the CPM2-1200-0025B and CPW5-1200-Z050B device datasheet.
- This product has not been designed or tested for use in, and is not intended for use in, applications implanted into the human body nor in applications in which failure of the product could lead to death, personal injury or property damage, including but not limited to equipment used in the operation of nuclear facilities, life-support machines, cardiac defibrillators or similar emergency medical equipment, aircraft navigation or communication or control systems, air traffic control systems.
- The product described is not eligible for Distributor Stock Rotation or Inventory Price Protection.